

ESP32 Datasheet



Espressif Systems

August 25, 2016

About This Guide

This document provides introduction to the specifications of ESP32 hardware.

The document structure is as follows:

Chapter	Title	Subject
Chapter 1	Overview	An overview of ESP32, including featured solutions, basic and advanced features, applications and development support
Chapter 2	Pin Definitions	Introduction to the pin layout and descriptions
Chapter 3	Functional Description	Description of the major functional modules
Chapter 4	Peripheral Interface	Description of the peripheral interfaces integrated on ESP32
Chapter 5	Electrical Characteristics	The electrical characteristics and data of ESP32
Chapter 6	Package Information	The package details of ESP32
Chapter 7	Supported Resources	The related documents and community resources for ESP32
Appendix	Touch Sensor	The touch sensor design and layout guidelines

Release Notes

Date	Version	Release notes
2016.08	V1.0	First release

Disclaimer and Copyright Notice

Information in this document, including URL references, is subject to change without notice. THIS DOCUMENT IS PROVIDED AS IS WITH NO WARRANTIES WHATSOEVER, INCLUDING ANY WARRANTY OF MERCHANTABILITY, NON-INFRINGEMENT, FITNESS FOR ANY PARTICULAR PURPOSE, OR ANY WARRANTY OTHERWISE ARISING OUT OF ANY PROPOSAL, SPECIFICATION OR SAMPLE.

All liability, including liability for infringement of any proprietary rights, relating to use of information in this document is disclaimed. No licenses express or implied, by estoppel or otherwise, to any intellectual property rights are granted herein. The Wi-Fi Alliance Member logo is a trademark of the Wi-Fi Alliance. The Bluetooth logo is a registered trademark of Bluetooth SIG.

All trade names, trademarks and registered trademarks mentioned in this document are property of their respective owners, and are hereby acknowledged.

Copyright © 2016 Espressif Inc. All rights reserved.

Contents

1	Overview	1
1.1	Featured Solutions	1
1.1.1	Ultra Low Power Solution	1
1.1.2	Complete Integration Solution	1
1.2	Basic Protocols	1
1.2.1	Wi-Fi	1
1.2.2	Bluetooth	2
1.3	MCU and Advanced Features	3
1.3.1	CPU and Memory	3
1.3.2	Clocks and Timers	3
1.3.3	Advanced Peripheral Interfaces	3
1.3.4	Security	4
1.3.5	Development Support	4
1.4	Application	4
1.5	Block Diagram	5
2	Pin Definitions	6
2.1	Pin Layout	6
2.2	Pin Description	6
2.3	Power Scheme	8
2.4	Strapping Pins	9
3	Functional Description	10
3.1	CPU and Memory	10
3.1.1	CPU	10
3.1.2	Internal Memory	10
3.1.3	External Flash and SRAM	10
3.1.4	Memory Map	11
3.2	Timers and Watchdogs	13
3.2.1	64-bit Timers	13
3.2.2	Watchdog Timers	13
3.3	System Clocks	13
3.3.1	CPU Clock	13
3.3.2	RTC Clock	14
3.3.3	Audio PLL Clock	14
3.4	Radio	14
3.4.1	2.4 GHz Receiver	14
3.4.2	2.4 GHz Transmitter	15
3.4.3	Clock Generator	15
3.5	Wi-Fi	15
3.5.1	Wi-Fi Radio and Baseband	15
3.5.2	Wi-Fi MAC	16
3.5.3	Wi-Fi Firmware	16
3.5.4	Packet Traffic Arbitration (PTA)	16

3.6	Bluetooth	17
3.6.1	Bluetooth Radio and Baseband	17
3.6.2	Bluetooth Interface	17
3.6.3	Bluetooth Stack	17
3.6.4	Bluetooth Link Controller	18
3.7	RTC and Low-Power Management	19
4	Peripheral Interface	21
4.1	General Purpose Input / Output Interface (GPIO)	21
4.2	Analog-to-Digital Converter (ADC)	21
4.3	Ultra Low Noise Analog Pre-Amplifier	21
4.4	Hall Sensor	21
4.5	Digital-to-Analog Converter (DAC)	21
4.6	Temperature Sensor	22
4.7	Touch Sensor	22
4.8	Ultra-Lower-Power Coprocessor	22
4.9	Ethernet MAC Interface	23
4.10	SD/SDIO/MMC Host Controller	23
4.11	Universal Asynchronous Receiver Transmitter (UART)	23
4.12	I2C Interface	24
4.13	I2S Interface	24
4.14	Infrared Remote Controller	24
4.15	Pulse Counter	24
4.16	Pulse Width Modulation (PWM)	24
4.17	LED PWM	25
4.18	Serial Peripheral Interface (SPI)	25
4.19	Accelerator	25
5	Electrical Characteristics	26
5.1	Absolute Maximum Ratings	26
5.2	Recommended Operating Conditions	26
5.3	RF Power Consumption Specifications	27
5.4	Wi-Fi Radio	27
5.5	Bluetooth Radio	28
5.5.1	Receiver - Basic Data Rate	28
5.5.2	Transmitter - Basic Data Rate	28
5.5.3	Receiver - Enhanced Data Rate	29
5.5.4	Transmitter - Enhanced Data Rate	29
5.6	Bluetooth LE Radio	30
5.6.1	Receiver	30
5.6.2	Transmitter	30
6	Package Information	32
7	Supported Resources	33
7.1	Related Documentation	33
7.2	Community Resources	33

Appendix A - Touch Sensor

34

Appendix B - Code Examples

36

List of Tables

1	Pin Description	6
2	Strapping Pins	9
3	Memory and Peripheral Mapping	11
4	Functionalities Depending on the Power Modes	19
5	Power Consumption by Power Modes	20
6	Capacitive Sensing GPIOs Available on ESP32	22
7	Absolute Maximum Ratings	26
8	Recommended Operating Conditions	26
9	RF Power Consumption Specifications	27
10	Wi-Fi Radio Characteristics	27
11	Receiver Characteristics-Basic Data Rate	28
12	Transmitter Characteristics - Basic Data Rate	28
13	Receiver Characteristics - Enhanced Data Rate	29
14	Transmitter Characteristics - Enhanced Data Rate	29
15	Receiver Characteristics - BLE	30
16	Transmitter Characteristics - BLE	30

List of Figures

1	Function Block Diagram	5
2	ESP32 Pin Layout	6
3	Address Mapping Structure	11
4	QFN48 (6x6 mm) Package	32
5	A Typical Touch Sensor Application	34
6	Electrode Pattern Requirements	34
7	Sensor Track Routing Requirements	35

1. Overview

ESP32 is a single chip 2.4 GHz Wi-Fi and Bluetooth combo chip designed with TSMC ultra low power 40 nm technology. It is designed and optimized for the best power performance, RF performance, robustness, versatility, features and reliability, for a wide variety of applications, and different power profiles.

1.1 Featured Solutions

1.1.1 Ultra Low Power Solution

ESP32 is designed for mobile, wearable electronics, and Internet of Things (IoT) applications. It has many features of the state-of-the-art low power chips, including fine resolution clock gating, power modes, and dynamic power scaling.

For instance, in a low-power IoT sensor hub application scenario, ESP32 is woken up periodically and only when a specified condition is detected; low duty cycle is used to minimize the amount of energy that the chip expends. The output power of the power amplifier is also adjustable to achieve an optimal trade off between communication range, data rate and power consumption.

Note:

For more information, refer to Section 3.7 RTC and Low-Power Management.

1.1.2 Complete Integration Solution

ESP32 is the most integrated solution for Wi-Fi + Bluetooth applications in the industry with less than 10 external components. ESP32 integrates the antenna switch, RF balun, power amplifier, low noise receive amplifier, filters, and power management modules. As such, the entire solution occupies minimal Printed Circuit Board (PCB) area.

ESP32 uses CMOS for single-chip fully-integrated radio and baseband, and also integrates advanced calibration circuitries that allow the solution to dynamically adjust itself to remove external circuit imperfections or adjust to changes in external conditions.

As such, the mass production of ESP32 solutions does not require expensive and specialized Wi-Fi test equipment.

1.2 Basic Protocols

1.2.1 Wi-Fi

- 802.11 b/g/n/e/i
- 802.11 n (2.4 GHz), up to 150 Mbps
- 802.11 e: QoS for wireless multimedia technology
- WMM-PS, UAPSD
- A-MPDU and A-MSDU aggregation
- Block ACK

- Fragmentation and defragmentation
- Automatic Beacon monitoring/scanning
- 802.11 i security features: pre-authentication and TSN
- Wi-Fi Protected Access (WPA)/WPA2/WPA2-Enterprise/Wi-Fi Protected Setup (WPS)
- Infrastructure BSS Station mode/SoftAP mode
- Wi-Fi Direct (P2P), P2P Discovery, P2P Group Owner mode and P2P Power Management
- UMA compliant and certified
- Antenna diversity and selection

Note:

For more information, refer to Section 3.5 Wi-Fi.

1.2.2 Bluetooth

- Compliant with Bluetooth v4.2 BR/EDR and BLE specification
- Class-1, class-2 and class-3 transmitter without external power amplifier
- Enhanced power control
- +10 dBm transmitting power
- NZIF receiver with -98 dBm sensitivity
- Adaptive Frequency Hopping (AFH)
- Standard HCI based on SDIO/SPI/UART
- High speed UART HCI, up to 4 Mbps
- BT 4.2 controller and host stack
- Service Discover Protocol (SDP)
- General Access Profile (GAP)
- Security Manage Protocol (SMP)
- Bluetooth Low Energy (BLE)
- ATT/GATT
- HID
- All GATT-based profile supported
- SPP-Like GATT-based profile
- BLE Beacon
- A2DP/AVRCP/SPP, HSP/HFP, RFCOMM
- CVSD and SBC for audio codec
- Bluetooth Piconet and Scatternet

1.3 MCU and Advanced Features

1.3.1 CPU and Memory

- Xtensa® Dual-Core 32-bit LX6 microprocessors, up to 600 DMIPS
- 448 KByte ROM
- 520 KByte SRAM
- 16 KByte SRAM in RTC
- QSPI Flash/SRAM, up to 4 x 16 MBytes
- Power supply: 2.2 V to 3.6 V

1.3.2 Clocks and Timers

- Internal 8 MHz oscillator with calibration
- Internal RC oscillator with calibration
- External 2 MHz to 40 MHz crystal oscillator
- External 32 kHz crystal oscillator for RTC with calibration
- Two timer groups, including 2 x 64-bit timers and 1 x main watchdog in each group
- RTC timer with sub-second accuracy
- RTC watchdog

1.3.3 Advanced Peripheral Interfaces

- 12-bit SAR ADC up to 18 channels
- 2 x 8-bit D/A converters
- 10 x touch sensors
- Temperature sensor
- 4 x SPI
- 2 x I2S
- 2 x I2C
- 3 x UART
- 1 host (SD/eMMC/SDIO)
- 1 slave (SDIO/SPI)
- Ethernet MAC interface with dedicated DMA and IEEE 1588 support
- CAN 2.0
- IR (TX/RX)
- Motor PWM
- LED PWM up to 16 channels
- Hall sensor
- Ultra low power analog pre-amplifier

1.3.4 Security

- IEEE 802.11 standard security features all supported, including WPA, WPA/WPA2 and WAPI
- Secure boot
- Flash encryption
- 1024-bit OTP, up to 768-bit for customers
- Cryptographic hardware acceleration:
 - AES
 - HASH (SHA-2) library
 - RSA
 - ECC
 - Random Number Generator (RNG)

1.3.5 Development Support

- SDK Firmware for fast on-line programming
- Open source toolchains based on GCC

Note:

For more information, refer to Chapter 7 Supported Resources.

1.4 Application

- Generic low power IoT sensor hub
- Generic low power IoT loggers
- Video streaming from camera
- Over The Top (OTT) devices
- Music players
 - Internet music players
 - Audio streaming devices
- Wi-Fi enabled toys
 - Loggers
 - Proximity sensing toys
- Wi-Fi enabled speech recognition devices
- Audio headsets
- Smart power plugs
- Home automation
- Mesh network

- Industrial wireless control
- Baby monitors
- Wearable electronics
- Wi-Fi location-aware devices
- Security ID tags
- Healthcare
 - Proximity and movement monitoring trigger devices
 - Temperature sensing loggers

1.5 Block Diagram

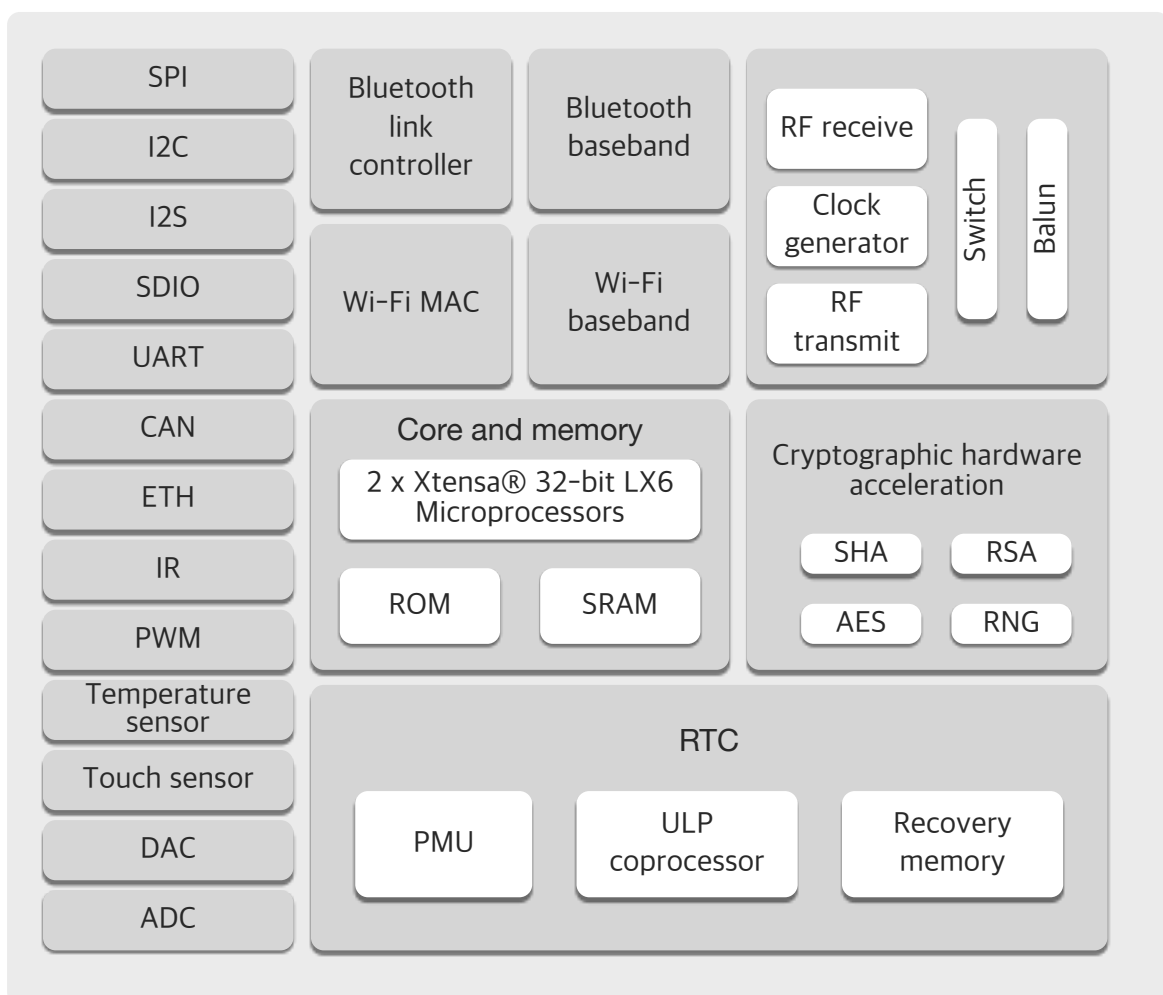

Figure 1: Function Block Diagram

2. Pin Definitions

2.1 Pin Layout

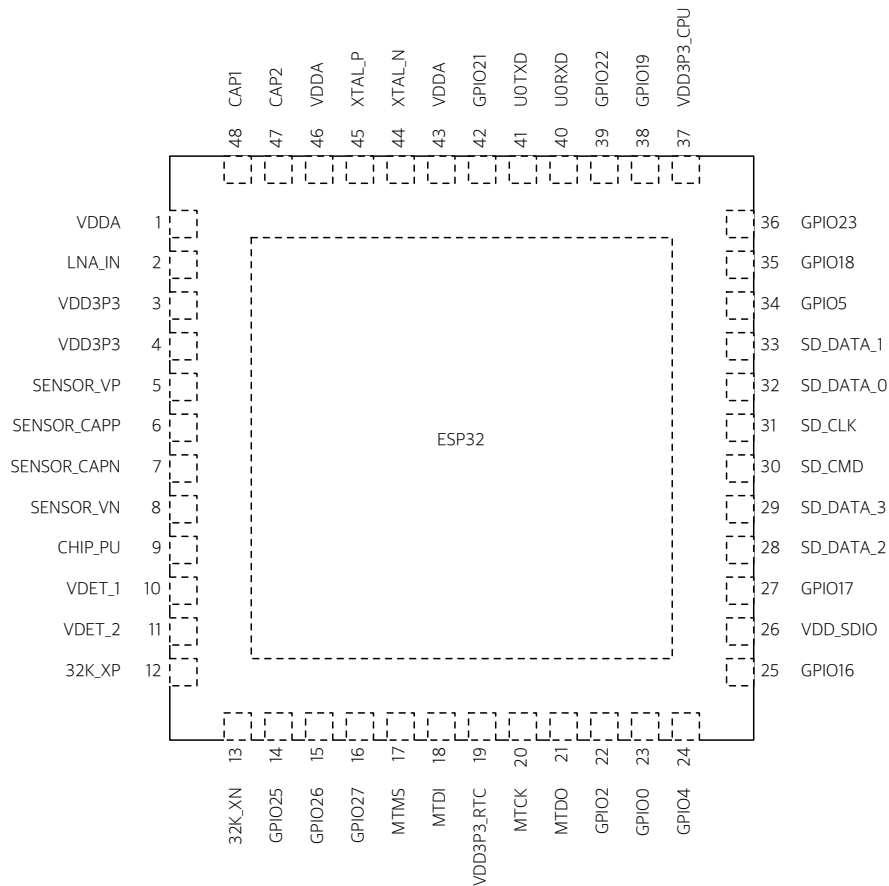

Figure 2: ESP32 Pin Layout

2.2 Pin Description

Table 1: Pin Description

Name	No.	Type	Function
Analog			
VDDA	1	P	Analog power supply (2.3V ~ 3.6V)
LNA_IN	2	I/O	RF input and output
VDD3P3	3	P	Amplifier power supply (2.3V ~ 3.6V)
VDD3P3	4	P	Amplifier power supply (2.3V ~ 3.6V)
VDD3P3_RTC			
SENSOR_VP	5	I	GPIO36, ADC_PRE_AMP, ADC1_CH0, RTC_GPIO0 Note: Connects 270 pF capacitor from SENSOR_VP to SENSOR_CAPP when used as ADC_PRE_AMP.

Name	No.	Type	Function
SENSOR_CAPP	6	I	GPIO37, ADC_PRE_AMP, ADC1_CH1, RTC_GPIO1 Note: Connects 270 pF capacitor from SENSOR_VP to SENSOR_CAPP when used as ADC_PRE_AMP.
SENSOR_CAPN	7	I	GPIO38, ADC1_CH2, ADC_PRE_AMP, RTC_GPIO2 Note: Connects 270 pF capacitor from SENSOR_VN to SENSOR_CAPN when used as ADC_PRE_AMP.
SENSOR_VN	8	I	GPIO39, ADC1_CH3, ADC_PRE_AMP, RTC_GPIO3 Note: Connects 270 pF capacitor from SENSOR_VN to SENSOR_CAPN when used as ADC_PRE_AMP.
CHIP_PU	9	I	Chip Enable (Active High) High: On, chip works properly Low: Off, chip works at the minimum power Note: Do not leave CHIP_PU pin floating
VDET_1	10	I	GPIO34, ADC1_CH6, RTC_GPIO4
VDET_2	11	I	GPIO35, ADC1_CH7, RTC_GPIO5
32K_XP	12	I/O	GPIO32, 32K_XP (32.768 kHz crystal oscillator input), ADC1_CH4, TOUCH9, RTC_GPIO9
32K_XN	13	I/O	GPIO33, 32K_XN (32.768 kHz crystal oscillator output), ADC1_CH5, TOUCH8, RTC_GPIO8
GPIO25	14	I/O	GPIO25, DAC_1, ADC2_CH8, RTC_GPIO6, EMAC_RXD0
GPIO26	15	I/O	GPIO26, DAC_2, ADC2_CH9, RTC_GPIO7, EMAC_RXD1
GPIO27	16	I/O	GPIO27, ADC2_CH7, TOUCH7, RTC_GPIO17, EMAC_RX_DV
MTMS	17	I/O	GPIO14, ADC2_CH6, TOUCH6, RTC_GPIO16, MTMS, HSPI-CLK, HS2_CLK, SD_CLK, EMAC_TXD2
MTDI	18	I/O	GPIO12, ADC2_CH5, TOUCH5, RTC_GPIO15, MTDI, HSPIQ, HS2_DATA2, SD_DATA2, EMAC_TXD3
VDD3P3_RTC	19	P	RTC IO power supply input (1.8V - 3.3V)
MTCK	20	I/O	GPIO13, ADC2_CH4, TOUCH4, RTC_GPIO14, MTCK, HSPID, HS2_DATA3, SD_DATA3, EMAC_RX_ER
MTDO	21	I/O	GPIO15, ADC2_CH3, TOUCH3, RTC_GPIO13, MTDO, HSPICS0, HS2_CMD, SD_CMD, EMAC_RXD3
GPIO2	22	I/O	GPIO2, ADC2_CH2, TOUCH2, RTC_GPIO12, HSPIWP, HS2_DATA0, SD_DATA0
GPIO0	23	I/O	GPIO0, ADC2_CH1, TOUCH1, RTC_GPIO11, CLK_OUT1, EMAC_TX_CLK
GPIO4	24	I/O	GPIO4, ADC2_CH0, TOUCH0, RTC_GPIO10, HSPIHD, HS2_DATA1, SD_DATA1, EMAC_TX_ER
VDD_SDIO			
GPIO16	25	I/O	GPIO16, HS1_DATA4, U2RXD, EMAC_CLK_OUT
VDD_SDIO	26	P	1.8V or 3.3V power supply output
GPIO17	27	I/O	GPIO17, HS1_DATA5, U2TXD, EMAC_CLK_OUT_180
SD_DATA_2	28	I/O	GPIO9, SD_DATA2, SPIHD, HS1_DATA2, U1RXD
SD_DATA_3	29	I/O	GPIO10, SD_DATA3, SPIWP, HS1_DATA3, U1TXD
SD_CMD	30	I/O	GPIO11, SD_CMD, SPICS0, HS1_CMD, U1RTS
SD_CLK	31	I/O	GPIO6, SD_CLK, SPICLK, HS1_CLK, U1CTS

Name	No.	Type	Function
SD_DATA_0	32	I/O	GPIO7, SD_DATA0, SPIQ, HS1_DATA0, U2RTS
SD_DATA_1	33	I/O	GPIO8, SD_DATA1, SPID, HS1_DATA1, U2CTS
VDD3P3_CPU			
GPIO5	34	I/O	GPIO5, VSPICS0, HS1_DATA6, EMAC_RX_CLK
GPIO18	35	I/O	GPIO18, VSPICLK, HS1_DATA7
GPIO23	36	I/O	GPIO23, VSPID, HS1_STROBE
VDD3P3_CPU	37	P	CPU IO power supply input (1.8V - 3.3V)
GPIO19	38	I/O	GPIO19, VSPIQ, U0CTS, EMAC_TXD0
GPIO22	39	I/O	GPIO22, VSPIWP, U0RTS, EMAC_TXD1
U0RXD	40	I/O	GPIO3, U0RXD, CLK_OUT2
U0TXD	41	I/O	GPIO1, U0TXD, CLK_OUT3, EMAC_RXD2
GPIO21	42	I/O	GPIO21, VSPIHD, EMAC_TX_EN
Analog			
VDDA	43	I/O	Analog power supply (2.3V - 3.6V)
XTAL_N	44	O	External crystal output
XTAL_P	45	I	External crystal input
VDDA	46	P	Digital power supply for PLL (2.3V - 3.6V)
CAP2	47	I	Connects with a 3 nF capacitor and 20 k Ω resistor in parallel to CAP1
CAP1	48	I	Connects with a 10 nF series capacitor to ground

2.3 Power Scheme

ESP32 digital pins are divided into three different power domains:

- VDD3P3_RTC
- VDD3P3_CPU
- VDD_SDIO

VDD3P3_RTC is also the input power supply for RTC and CPU. **VDD3P3_CPU** is also the input power supply for CPU.

VDD_SDIO connects to the output of an internal LDO, whose input is **VDD3P3_RTC**. When **VDD_SDIO** is connected to the same PCB net together with **VDD3P3_RTC**; the internal LDO is disabled automatically.

The internal LDO can be configured as 1.8V, or the same voltage as **VDD3P3_RTC**. It can be powered off via software to minimize the current of Flash/SRAM during the deep-sleep mode.

Note:

It is required that the power supply of **VDD3P3_RTC**, **VDD3P3_CPU** and analog must be stable before the pin **CHIP_PU** is set at high level.

2.4 Strapping Pins

ESP32 has 6 strapping pins:

- MTDI: internal pull-down
- GPIO0: internal pull-up
- GPIO2: internal pull-down
- GPIO4: internal pull-down
- MTDO: internal pull-up
- GPIO5: internal pull-up

Software can read the value of these 6 bits from the register "GPIO_STRAPPING".

During the chip power-on reset, the latches of the strapping pins sample the voltage level as strapping bits of "0" or "1", and hold these bits until the chip is powered down or shut down. The strapping bits configure the device boot mode, the operating voltage of VDD_SDIO and other system initial settings.

Each strapping pin is connected with its internal pull-up/pull-down during the chip reset. Consequently, if a strapping pin is unconnected or the connected external circuit is high-impedance, the internal weak pull-up/pull-down will determine the default input level of the strapping pins.

To change the strapping bit values, users can apply the external pull-down/pull-up resistances, or apply the host MCU's GPIOs to control the voltage level of these pins when powering on ESP32.

After reset, the strapping pins work as the normal functions pins.

Refer to Table 2 for detailed boot modes configuration by strapping pins.

Table 2: Strapping Pins

Voltage of Internal LDO (VDD_SDIO)					
Pin	Default	3.3V		1.8V	
MTDI	Pull-down	0		1	
Bootling Mode					
Pin	Default	SPI Boot		Download Boot	
GPIO0	Pull-up	1		0	
GPIO2	Pull-down	Don't-care		0	
Debugging Log on U0TXD During Bootling					
Pin	Default	U0TXD Toggling		U0TXD Silent	
MTDO	Pull-up	1		0	
Timing of SDIO Slave					
Pin	Default	Falling-edge Input Falling-edge Output	Falling-edge Input Rising-edge Output	Rising-edge Input Falling-edge Output	Rising-edge Input Rising-edge Output
MTDO	Pull-up	0	0	1	1
GPIO5	Pull-up	0	1	0	1

Note:

Firmware can configure register bits to change the setting of "Voltage of Internal LDO (VDD_SDIO)" and "Timing of SDIO Slave" after bootling.

3. Functional Description

This chapter describes the functions implemented in ESP32.

3.1 CPU and Memory

3.1.1 CPU

ESP32 contains two low-power Xtensa® 32-bit LX6 microprocessors with the following features.

- 7-stage pipeline to support the clock frequency of up to 240 MHz
- 16/24-bit Instruction Set provides high code-density
- Support Floating Point Unit
- Support DSP instructions, such as 32-bit Multiplier, 32-bit Divider, and 40-bit MAC
- Support 32 interrupt vectors from about 70 interrupt sources

The dual CPUs interface through:

- Xtensa RAM/ROM Interface for instruction and data
- Xtensa Local Memory Interface for fast peripheral register access
- Interrupt with external and internal sources
- JTAG interface for debugging

3.1.2 Internal Memory

ESP32's internal memory includes:

- 448 KBytes ROM for booting and core functions
- 520 KBytes on-chip SRAM for data and instruction
- 8 KBytes SRAM in RTC, which is called RTC SLOW Memory and can be used for co-processor accessing during the deep-sleep mode
- 8 KBytes SRAM in RTC, which is called RTC FAST Memory and can be used for data storage and main CPU during RTC Boot from the deep-sleep mode
- 1 Kbit of EFUSE, of which 256 bits are used for the system (MAC address and chip configuration) and the remaining 768 bits are reserved for customer applications, including Flash-Encryption and Chip-ID

3.1.3 External Flash and SRAM

ESP32 supports 4 x 16 MBytes of external QSPI Flash and SRAM with hardware encryption based on AES to protect developer's programs and data.

ESP32 accesses external QSPI Flash and SRAM by the high-speed caches

- Up to 16 MBytes of external Flash are memory mapped into the CPU code space, supporting 8-bit, 16-bit and 32-bit access. Code execution is supported.

- Up to 8 MBytes of external Flash/SRAM are memory mapped into the CPU data space, supporting 8-bit, 16-bit and 32-bit access. Data read is supported on the Flash and SRAM. Data write is supported on the SRAM.

3.1.4 Memory Map

The structure of address mapping is shown in Figure 3. The memory and peripherals mapping of ESP32 is shown in Table 3.

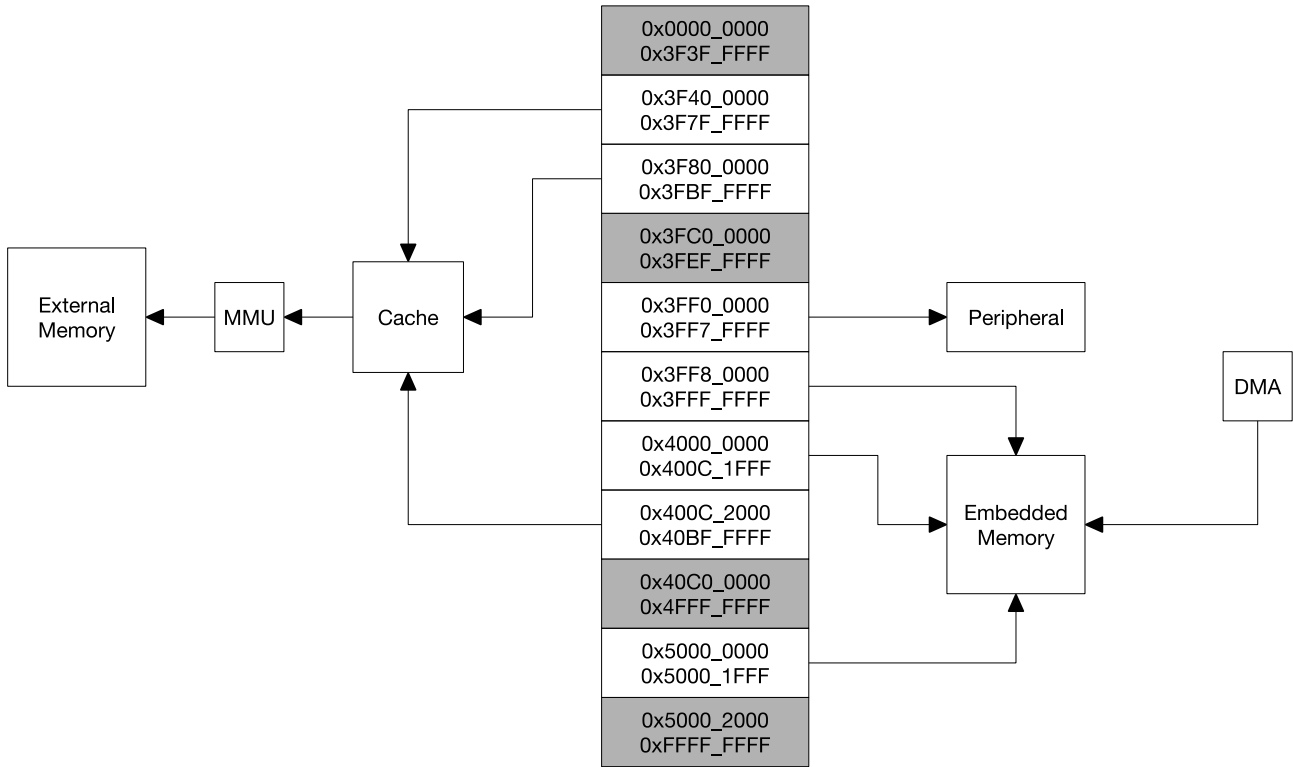

Figure 3: Address Mapping Structure

Table 3: Memory and Peripheral Mapping

Category	Target	Start Address	End Address	Size
Embedded Memory	Internal ROM 0	0x4000_0000	0x4005_FFFF	384 KB
	Internal ROM 1	0x3FF9_0000	0x3FF9_FFFF	64 KB
	Internal SRAM 0	0x4007_0000	0x4009_FFFF	192 KB
	Internal SRAM 1	0x3FFE_0000	0x3FFF_FFFF	128 KB
		0x400A_0000	0x400B_FFFF	
	Internal SRAM 2	0x3FFA_E000	0x3FFD_FFFF	200 KB
	RTC FAST Memory	0x3FF8_0000	0x3FF8_1FFF	8 KB
0x400C_0000		0x400C_1FFF		
RTC SLOW Memory	0x5000_0000	0x5000_1FFF	8 KB	
External Memory	External Flash	0x3F40_0000	0x3F7F_FFFF	4 MB
		0x400C_2000	0x40BF_FFFF	11 MB 248 KB
	External SRAM	0x3F80_0000	0x3FBF_FFFF	4 MB

Category	Target	Start Address	End Address	Size
Peripheral	DPort Register	0x3FF0_0000	0x3FF0_0FFF	4 KB
	AES Accelerator	0x3FF0_1000	0x3FF0_1FFF	4 KB
	RSA Accelerator	0x3FF0_2000	0x3FF0_2FFF	4 KB
	SHA Accelerator	0x3FF0_3000	0x3FF0_3FFF	4 KB
	Secure Boot	0x3FF0_4000	0x3FF0_4FFF	4 KB
	Cache MMU Table	0x3FF1_0000	0x3FF1_3FFF	16 KB
	PID Controller	0x3FF1_F000	0x3FF1_FFFF	4 KB
	UART0	0x3FF4_0000	0x3FF4_0FFF	4 KB
	SPI1	0x3FF4_2000	0x3FF4_2FFF	4 KB
	SPIO	0x3FF4_3000	0x3FF4_3FFF	4 KB
	GPIO	0x3FF4_4000	0x3FF4_4FFF	4 KB
	RTC	0x3FF4_8000	0x3FF4_8FFF	4 KB
	IO MUX	0x3FF4_9000	0x3FF4_9FFF	4 KB
	SDIO Slave	0x3FF4_B000	0x3FF4_BFFF	4 KB
	UDMA1	0x3FF4_C000	0x3FF4_CFFF	4 KB
	I2S0	0x3FF4_F000	0x3FF4_FFFF	4 KB
	UART1	0x3FF5_0000	0x3FF5_0FFF	4 KB
	I2C0	0x3FF5_3000	0x3FF5_3FFF	4 KB
	UDMA0	0x3FF5_4000	0x3FF5_4FFF	4 KB
	SDIO Slave	0x3FF5_5000	0x3FF5_5FFF	4 KB
	RMT	0x3FF5_6000	0x3FF5_6FFF	4 KB
	PCNT	0x3FF5_7000	0x3FF5_7FFF	4 KB
	SDIO Slave	0x3FF5_8000	0x3FF5_8FFF	4 KB
	LED PWM	0x3FF5_9000	0x3FF5_9FFF	4 KB
	Efuse Controller	0x3FF5_A000	0x3FF5_AFFF	4 KB
	Flash Encryption	0x3FF5_B000	0x3FF5_BFFF	4 KB
	PWM0	0x3FF5_E000	0x3FF5_EFFF	4 KB
	TIMG0	0x3FF5_F000	0x3FF5_FFFF	4 KB
	TIMG1	0x3FF6_0000	0x3FF6_0FFF	4 KB
	SPI2	0x3FF6_4000	0x3FF6_4FFF	4 KB
	SPI3	0x3FF6_5000	0x3FF6_5FFF	4 KB
	SYSCON	0x3FF6_6000	0x3FF6_6FFF	4 KB
	I2C1	0x3FF6_7000	0x3FF6_7FFF	4 KB
	SDMMC	0x3FF6_8000	0x3FF6_8FFF	4 KB
	EMAC	0x3FF6_9000	0x3FF6_AFFF	8 KB
	PWM1	0x3FF6_C000	0x3FF6_CFFF	4 KB
	I2S1	0x3FF6_D000	0x3FF6_DFFF	4 KB
	UART2	0x3FF6_E000	0x3FF6_EFFF	4 KB
	PWM2	0x3FF6_F000	0x3FF6_FFFF	4 KB
	PWM3	0x3FF7_0000	0x3FF7_0FFF	4 KB
	RNG	0x3FF7_5000	0x3FF7_5FFF	4 KB

3.2 Timers and Watchdogs

3.2.1 64-bit Timers

There are four general-purpose timers embedded in the ESP32. They are all 64-bit generic timers which are based on 16-bit prescalers and 64-bit auto-reload-capable up/downcounters.

The timers feature:

- A 16-bit clock prescaler, from 2 to 65536
- A 64-bit time-base counter
- Configurable up/down time-base counter: incrementing or decrementing
- Halt and resume of time-base counter
- Auto-reload at alarming
- Software-controlled instant reload
- Level and edge interrupt generation

3.2.2 Watchdog Timers

The ESP32 has three watchdog timers: one in each of the two timer modules (called the Main Watchdog Timer, or MWDT) and one in the RTC module (called the RTC Watchdog Timer, or RWDT). These watchdog timers are intended to recover from an unforeseen fault, causing the application program to abandon its normal sequence. A watchdog timer has 4 stages. Each stage may take one of three or four actions on expiry of a programmed time period for this stage unless the watchdog is fed or disabled. The actions are: interrupt, CPU reset, and core reset, and system reset. Only the RWDT can trigger the system reset, and is able to reset the entire chip, including the RTC itself. A timeout value can be set for each stage individually.

During Flash boot the RWDT and the first MWDT start automatically in order to detect and recover from booting problems.

The ESP32 watchdogs have the following features:

- 4 stages, each can be configured or disabled separately
- Programmable time period for each stage
- One of 3 or 4 possible actions (interrupt, CPU reset, core reset, and system reset) on expiration of each stage
- 32-bit expiry counter
- Write protection, to prevent the RWDT and MWDT configuration from being inadvertently altered
- SPI Flash boot protection

If the boot process from an SPI Flash does not complete within a predetermined time period, the watchdog will reboot the entire system.

3.3 System Clocks

3.3.1 CPU Clock

Upon reset, an external crystal clock source (2 MHz ~ 60 MHz), is selected as the default CPU clock. The external crystal clock source also connects to a PLL to generate a high frequency clock (typically 160 MHz).

In addition to this, ESP32 has an internal 8 MHz oscillator, of which the accuracy is guaranteed by design and is stable over temperature (within 1% accuracy). Hence, the application can then select from the external crystal clock source, the PLL clock or the internal 8 MHz oscillator. The selected clock source drives the CPU clock, directly or after division, depending on the application.

3.3.2 RTC Clock

The RTC clock has five possible sources:

- external low speed (32 kHz) crystal clock
- external crystal clock divided by 4
- internal RC oscillator (typically about 150 kHz and adjustable)
- internal 8 MHz oscillator
- internal 31.25 kHz clock (derived from the internal 8 MHz oscillator divided by 256)

When the chip is in the normal power mode and needs faster CPU accessing, the application can choose the external high speed crystal clock divided by 4 or the internal 8 MHz oscillator. When the chip operates in the low power mode, the application chooses the external low speed (32 kHz) crystal clock, the internal RC clock or the internal 31.25 kHz clock.

3.3.3 Audio PLL Clock

The audio clock is generated by the ultra low noise fractional-N PLL. The output frequency of the audio PLL is programmable, from 16 MHz to 128 MHz, given by the following formula:

$$f_{out} = \frac{f_{xtal} N_{div}}{M_{div} 2^{K_{div}}}$$

where f_{out} is the output frequency, f_{xtal} is the frequency of the crystal oscillator, and N_{div} , M_{div} and K_{div} are all integer values, configurable by registers.

3.4 Radio

The ESP32 radio consists of the following main blocks:

- 2.4 GHz receiver
- 2.4 GHz transmitter
- bias and regulators
- balun and transmit-receive switch
- clock generator

3.4.1 2.4 GHz Receiver

The 2.4 GHz receiver down-converts the 2.4 GHz RF signal to quadrature baseband signals and converts them to the digital domain with 2 high-resolution, high-speed ADCs. To adapt to varying signal channel conditions, RF filters, Automatic Gain Control (AGC), DC offset cancelation circuits and baseband filters are integrated within ESP32.

3.4.2 2.4 GHz Transmitter

The 2.4 GHz transmitter up-converts the quadrature baseband signals to the 2.4 GHz RF signal, and drives the antenna with a high powered Complementary Metal Oxide Semiconductor (CMOS) power amplifier. The use of digital calibration further improves the linearity of the power amplifier, enabling state-of-the-art performance of delivering +20.5 dBm of average power for 802.11b transmission and +17 dBm for 802.11n transmission.

Additional calibrations are integrated to cancel any imperfections of the radio, such as:

- Carrier leakage
- I/Q phase matching
- Baseband nonlinearities
- RF nonlinearities
- Antenna matching

These built-in calibration routines reduce the amount of time and required for product test and make test equipment unnecessary.

3.4.3 Clock Generator

The clock generator generates quadrature 2.4 GHz clock signals for the receiver and transmitter. All components of the clock generator are integrated on the chip, including all inductors, varactors, filters, regulators and dividers. The clock generator has built-in calibration and self test circuits. Quadrature clock phases and phase noise are optimized on-chip with patented calibration algorithms to ensure the best performance of the receiver and transmitter.

3.5 Wi-Fi

ESP32 implements TCP/IP, full 802.11 b/g/n/e/i WLAN MAC protocol, and Wi-Fi Direct specification. It supports Basic Service Set (BSS) STA and SoftAP operations under the Distributed Control Function (DCF) and P2P group operation compliant with the latest Wi-Fi P2P protocol.

Passive or active scanning, as well as the P2P discovery procedure are performed autonomously when initiated by appropriate commands. Power management is handled with minimum host interaction to minimize active duty period.

3.5.1 Wi-Fi Radio and Baseband

The ESP32 Wi-Fi Radio and Baseband support the following features:

- 802.11b and 802.11g data-rates
- 802.11n MCS0-7 in both 20 MHz and 40 MHz bandwidth
- 802.11n MCS32
- 802.11n 0.4 μ S guard-interval
- Data-rate up to 150 Mbps
- Receiving STBC 2x1
- Up to 21 dBm transmitting power
- Adjustable transmitting power

- Antenna diversity and selection (software-managed hardware)

3.5.2 Wi-Fi MAC

The ESP32 Wi-Fi MAC applies low level protocol functions automatically as follows:

- Request To Send (RTS), Clear To Send (CTS) and Acknowledgement (ACK/BA)
- Fragmentation and defragmentation
- Aggregation AMPDU and AMSDU
- WMM, U-APSD
- 802.11 e: QoS for wireless multimedia technology
- CCMP (CBC-MAC, counter mode), TKIP (MIC, RC4), WAPI (SMS4), WEP (RC4) and CRC
- Frame encapsulation (802.11h/RFC 1042)
- Automatic beacon monitoring/scanning

3.5.3 Wi-Fi Firmware

The ESP32 Wi-Fi Firmware provides the following functions:

- Infrastructure BSS Station mode / P2P mode / softAP mode support
- P2P Discovery, P2P Group Owner, P2P Group Client and P2P Power Management
- WPA/WPA2-Enterprise and WPS driver
- Additional 802.11i security features such as pre-authentication and TSN
- Open interface for various upper layer authentication schemes over EAP such as TLS, PEAP, LEAP, SIM, AKA or customer specific
- Clock/power gating combined with 802.11-compliant power management dynamically adapted to current connection condition providing minimal power consumption
- Adaptive rate fallback algorithm sets the optimal transmission rate and transmit power based on actual Signal Noise Ratio (SNR) and packet loss information
- Automatic retransmission and response on MAC to avoid packet discarding on slow host environment

3.5.4 Packet Traffic Arbitration (PTA)

ESP32 has a configurable Packet Traffic Arbitration (PTA) that provides flexible and exact timing Bluetooth co-existence support. It is a combination of both Frequency Division Multiplexing (FDM) and Time Division Multiplexing (TDM), and coordinates the protocol stacks.

- It is preferable that Wi-Fi works in the 20 MHz bandwidth mode to decrease its interference with BT.
- BT applies AFH (Adaptive Frequency Hopping) to avoid using the channels within Wi-Fi bandwidth.
- Wi-Fi MAC limits the time duration of Wi-Fi packets, and does not transmit the long Wi-Fi packets by the lowest data-rates.
- Normally BT packets are of higher priority than normal Wi-Fi packets.
- Protect the critical Wi-Fi packets, including beacon transmission and receiving, ACK/BA transmission and receiving.

- Protect the highest BT packets, including inquiry response, page response, LMP data and response, park beacons, the last poll period, SCO/eSCO slots, and BLE event sequence.
- Wi-Fi MAC apply CTS-to-self packet to protect the time duration of BT transfer.
- In the P2P Group Own (GO) mode, Wi-Fi MAC applies a Notice of Absence (NoA) packet to disable Wi-Fi transfer to reserve time for BT.
- In the STA mode, Wi-Fi MAC applies a NULL packet with the Power-Save bit to disable WiFi transfer to reserve time for BT.

3.6 Bluetooth

ESP32 integrates Bluetooth link controller and Bluetooth baseband, which carry out the baseband protocols and other low-level link routines, such as modulation/demodulation, packets processing, bit stream processing, frequency hopping, etc.

3.6.1 Bluetooth Radio and Baseband

The ESP32 Bluetooth Radio and Baseband support the following features:

- Class-1, class-2 and class-3 transmit output powers and over 30 dB dynamic control range
- $\pi/4$ DQPSK and 8 DPSK modulation
- High performance in NZIF receiver sensitivity with over 98 dB dynamic range
- Class-1 operation without external PA
- Internal SRAM allows full speed data transfer, mixed voice and data, and full piconet operation
- Logic for forward error correction, header error control, access code correlation, CRC, demodulation, encryption bit stream generation, whitening and transmit pulse shaping
- ACL, SCO, eSCO and AFH
- A-law, μ -law and CVSD digital audio CODEC in PCM interface
- SBC audio CODEC
- Power management for low power applications
- SMP with 128-bit AES

3.6.2 Bluetooth Interface

- Provides UART HCI interface, up to 4 Mbps
- Provides SDIO / SPI HCI interface
- Provides I2C interface for the host to do configuration
- Provides PCM / I2S audio interface

3.6.3 Bluetooth Stack

The Bluetooth stack of ESP32 is compliant with Bluetooth v4.2 BR / EDR and BLE specification.

3.6.4 Bluetooth Link Controller

The link controller operates in three major states: standby, connection and sniff. It enables multi connection and other operations like inquiry, page, and secure simple pairing, and therefore enables Piconet and Scatternet. Below are the features:

- Classic Bluetooth
 - Device Discovery (inquiry and inquiry scan)
 - Connection establishment (page and page scan)
 - Multi connections
 - Asynchronous data reception and transmission
 - Synchronous links (SCO/eSCO)
 - Master/Slave Switch
 - Adaptive Frequency Hopping and Channel assessment
 - Broadcast encryption
 - Authentication and encryption
 - Secure Simple Pairing
 - Multi-point and scatternet management
 - Sniff mode
 - Connectionless Slave Broadcast (transmitter and receiver)
 - Enhanced power control
 - Ping
- Bluetooth Low Energy
 - Advertising
 - Scanning
 - Multiple connections
 - Asynchronous data reception and transmission
 - Adaptive Frequency Hopping and Channel assessment
 - Connection parameter update
 - Data Length Extension
 - Link Layer Encryption
 - LE Ping

3.7 RTC and Low-Power Management

With the advanced power management technologies, ESP32 can switch between different power modes (see Table 4).

- Power mode
 - Active mode: The chip radio is powered on. The chip can receive, transmit, or listen.
 - Modem-sleep mode: The CPU is operational and the clock is configurable. The Wi-Fi/Bluetooth base-band and radio are disabled.
 - Light-sleep mode: The CPU is paused. The RTC and ULP-coprocessor are running. Any wake-up events (MAC, host, RTC timer, or external interrupts) will wake up the chip.
 - Deep-sleep mode: Only RTC is powered on. Wi-Fi and Bluetooth connection data are stored in RTC memory. The ULP-coprocessor can work.
 - Hibernate mode: The internal 8MHz oscillator and ULP-coprocessor are disabled. The RTC recovery memory are power-down. Only one RTC timer on the slow clock and some RTC GPIOs are active. The RTC timer or the RTC GPIOs can wake up the chip from the Hibernate mode.
- Sleep Pattern
 - Association sleep pattern: The power mode switches between the active mode and modem/light-sleep mode during this sleep pattern. The CPU, Wi-Fi, Bluetooth, and radio are woken up at predetermined intervals to keep Wi-Fi/BT connections alive.
 - ULP sensor-monitored pattern: The main CPU is in the deep-sleep mode. The ULP co-processor does sensor measurements and wakes up the main system, based on the measured data from sensors.

Table 4: Functionalities Depending on the Power Modes

Power mode	Active	Modem-sleep	Light-sleep	Deep-sleep	Hibernate
Sleep pattern	Association sleep pattern			ULP sensor-monitored pattern	-
CPU	ON	PAUSE	ON	OFF	OFF
Wi-Fi/BT base-band and radio	ON	OFF	OFF	OFF	OFF
RTC	ON	ON	ON	ON	OFF
ULP co-processor	ON	ON	ON	ON/OFF	OFF

The power consumption varies with different power modes/sleep patterns and work status of functional modules (see Table 5).

Table 5: Power Consumption by Power Modes

Power mode	Description	Power consumption
Active (RF working)	Wi-Fi Tx packet 13 dBm ~ 21 dBm	160 ~ 260 mA
	Wi-Fi / BT Tx packet 0 dBm	120 mA
	Wi-Fi / BT Rx and listening	80 ~ 90 mA
	Association sleep pattern (by light-sleep)	0.9 mA@DTIM3, 1.2 mA@DTIM1
Modem-sleep	The CPU is powered on.	Max speed: 20 mA
		Normal speed: 5 ~ 10 mA
		Slow speed: 3 mA
Light-sleep	-	0.8 mA
Deep-sleep	The ULP co-processor is powered on.	0.5 mA
	ULP sensor-monitored pattern	25 μ A @1% duty
	RTC timer + RTC memory	10 μ A
Hibernate	RTC timer only	2.5 μ A

Note:

For more information about RF power consumption, refer to Section 5.3 RF Power Consumption Specifications.

4. Peripheral Interface

4.1 General Purpose Input / Output Interface (GPIO)

ESP32 has 48 GPIO pins which can be assigned to various functions by programming the appropriate registers. There are several kinds of GPIOs: digital only GPIOs, analog enabled GPIOs, capacitive touch enabled GPIOs, etc. Analog enabled GPIOs can be configured as digital GPIOs. Capacitive touch enabled GPIOs can be configured as digital GPIOs.

Each digital enabled GPIO can be configured to internal pull-up or pull-down, or set to high impedance. When configured as an input, the input value can be read through the register. The input can also be set to edge-trigger or level-trigger to generate CPU interrupts. In short, the digital IO pins are bi-directional, non-inverting and tristate, including input and output buffer with tristate control. These pins can be multiplexed with other functions, such as the SDIO interface, UART, SI, etc. For low power operations, the GPIOs can be set to hold their states.

4.2 Analog-to-Digital Converter (ADC)

ESP32 integrates 12-bit SAR ADCs and supports measurements on 18 channels (analog enabled pins). Some of these pins can be used to build a programmable gain amplifier which is used for the measurement of small analog signals. The ULP-coprocessor in ESP32 is also designed to measure the voltages while operating in the sleep mode, to enable low power consumption; the CPU can be woken up by a threshold setting and/or via other triggers.

With the appropriate setting, the ADCs and the amplifier can be configured to measure voltages for a maximum of 18 pins.

4.3 Ultra Low Noise Analog Pre-Amplifier

ESP32 integrates an ultra low noise analog pre-amplifier that outputs to the ADC. The amplification ratio is given by the size of a pair of sampling capacitors that are placed off-chip. By using a larger capacitor, the sampling noise is reduced, but the settling time will be increased. The amplification ratio is also limited by the amplifier which peaks at about 60 dB gain.

4.4 Hall Sensor

ESP32 integrates a Hall sensor based on an N-carrier resistor. When the chip is in the magnetic field, the Hall sensor develops a small voltage laterally on the resistor, which can be directly measured by the ADC, or amplified by the ultra low noise analog pre-amplifier and then measured by the ADC.

4.5 Digital-to-Analog Converter (DAC)

Two 8-bit DAC channels can be used to convert two digital signals into two analog voltage signal outputs. The design structure is composed of integrated resistor strings and a buffer. This dual DAC supports power supply as input voltage reference and can drive other circuits. The dual channels support independent conversions.

4.6 Temperature Sensor

The temperature sensor generates a voltage that varies with temperature. The voltage is internally converted via an analog-to-digital converter into a digital code.

The temperature sensor has a range of -40°C to 125°C . As the offset of the temperature sensor varies from chip to chip due to process variation, together with the heat generated by the Wi-Fi circuitry itself (which affects measurements), the internal temperature sensor is only suitable for applications that detect temperature changes instead of absolute temperatures and for calibration purposes as well.

However, if the user calibrates the temperature sensor and uses the device in a minimally powered-on application, the results could be accurate enough.

4.7 Touch Sensor

ESP32 offers 10 capacitive sensing GPIOs which detect capacitive variations introduced by the GPIO's direct contact or close proximity with a finger or other objects. The low noise nature of the design and high sensitivity of the circuit allow relatively small pads to be used. Arrays of pads can also be used so that a larger area or more points can be detected. The 10 capacitive sensing GPIOs are listed in Table 6.

Table 6: Capacitive Sensing GPIOs Available on ESP32

Capacitive sensing signal name	Pin name
T0	GPIO4
T1	GPIO0
T2	GPIO2
T3	MTDO
T4	MTCK
T5	MTD1
T6	MTMS
T7	GPIO27
T8	32K_XN
T9	32K_XP

Note:

For more information about the touch sensor design and layout, refer to Appendix A Touch Sensor.

4.8 Ultra-Lower-Power Coprocessor

The ULP processor and RTC memory remains powered on during the deep-sleep mode. Hence, the developer can store a program for the ULP processor in the RTC memory to access the peripheral devices, internal timers and internal sensors during the deep-sleep mode. This is useful for designing applications where the CPU needs to be woken up by an external event, or timer, or a combination of these events, while maintaining minimal power consumption.

4.9 Ethernet MAC Interface

An IEEE-802.3-2008-compliant Media Access Controller (MAC) is provided for Ethernet LAN communications. ESP32 requires an external physical interface device (PHY) to connect to the physical LAN bus (twisted-pair, fiber, etc.). The PHY is connected to ESP32 through 17 signals of MII or 9 signals of RMII. With the Ethernet MAC (EMAC) interface, the following features are supported:

- 10 Mbps and 100 Mbps rates
- Dedicated DMA controller allowing high-speed transfer between the dedicated SRAM and Ethernet MAC
- Tagged MAC frame (VLAN support)
- Half-duplex (CSMA/CD) and full-duplex operation
- MAC control sublayer (control frames)
- 32-bit CRC generation and removal
- Several address filtering modes for physical and multicast address (multicast and group addresses)
- 32-bit status code for each transmitted or received frame
- Internal FIFOs to buffer transmit and receive frames. The transmit FIFO and the receive FIFO are both 512 words (32-bit)
- Hardware PTP (precision time protocol) in accordance with IEEE 1588 2008 (PTP V2)
- 25 MHz/50 MHz clock output

4.10 SD/SDIO/MMC Host Controller

An SD/SDIO/MMC host controller is available on ESP32 which supports the following features:

- Secure Digital memory (SD mem Version 3.0 and Version 3.01)
- Secure Digital I/O (SDIO Version 3.0)
- Consumer Electronics Advanced Transport Architecture (CE-ATA Version 1.1)
- Multimedia Cards (MMC Version 4.41, eMMC Version 4.5 and Version 4.51)

The controller allows clock output at up to 80 MHz and in three different data-bus modes: 1-bit, 4-bit and 8-bit. It supports two SD/SDIO/MMC4.41 cards in 4-bit data-bus mode. It also supports one SD card operating at 1.8 V level.

4.11 Universal Asynchronous Receiver Transmitter (UART)

ESP32 has three UART interfaces, i.e. UART0, UART1 and UART2, which provide asynchronous communication (RS232 and RS485) and IrDA support, and communicate at up to 5 Mbps. UART provides hardware management of the CTS and RTS signals and software flow control (XON and XOFF). All of the interfaces can be accessed by the DMA controller or directly by CPU.

4.12 I2C Interface

ESP32 has two I2C bus interfaces which can serve as I2C master or slave depending on the user's configuration. The I2C interfaces support:

- Standard mode (100 kbit/s)
- Fast mode (400 kbit/s)
- Up to 5 MHz, but constrained by SDA pull up strength
- 7-bit/10-bit addressing mode
- Dual addressing mode

Users can program command registers to control I2C interfaces to have more flexibility.

4.13 I2S Interface

Two standard I2S interfaces are available in ESP32. They can be operated in the master or slave mode, in full duplex and half-duplex communication modes, and can be configured to operate with an 8-/16-/32-/40-/48-bit resolution as input or output channels. BCK clock frequency from 10 kHz up to 40 MHz are supported. When one or both of the I2S interfaces are configured in the master mode, the master clock can be output to the external DAC/CODEC.

Both of the I2S interfaces have dedicated DMA controllers. PDM and BT PCM interfaces are supported.

4.14 Infrared Remote Controller

The infrared remote controller supports eight channels of infrared remote transmission and receiving. Through programming the pulse waveform, it supports various infrared protocols. Eight channels share a 512 x 32-bit block of memory to store the transmitting or receiving waveform.

4.15 Pulse Counter

The pulse counter captures pulse and counts pulse edges through seven modes. It has 8 channels; each channel captures four signals at a time. The four input signals include two pulse signals and two control signals. When the counter reaches a defined threshold, an interrupt is generated.

4.16 Pulse Width Modulation (PWM)

The Pulse Width Modulation (PWM) controller can be used for driving digital motors and smart lights. The controller consists of PWM timers, the PWM operator and a dedicated capture sub-module. Each timer provides timing in synchronus or independent form, and each PWM operator generates the waveform for one PWM channel. The dedicated capture sub-module can accurately capture external timing events.

4.17 LED PWM

The LED PWM controller can generate 16 independent channels of digital waveforms with the configurable periods and configurable duties.

The 16 channels of digital waveforms operate at 80 MHz APB clock, among which 8 channels have the option of using the 8 MHz oscillator clock. Each channel can select a 20-bit timer with configurable counting range and its accuracy of duty can be up to 16 bits with the 1 ms period.

The software can change the duty immediately. Moreover, each channel supports step-by-step duty increasing or decreasing automatically. It is useful for the LED RGB color gradient generator.

4.18 Serial Peripheral Interface (SPI)

ESP32 features three SPIs (SPI, HSPI and VSPI) in slave and master modes in 1-line full-duplex and 1/2/4-line half-duplex communication modes. These SPIs also support the following general-purpose SPI features:

- 4 timing modes of the SPI format transfer that depend on the polarity (POL) and the phase (PHA)
- up to 80 MHz and the divided clocks of 80 MHz
- up to 64-Byte FIFO

All SPIs can also be used to connect to the external Flash/SRAM and LCD. Each SPI can be served by DMA controllers.

4.19 Accelerator

ESP32 is equipped with hardware accelerators of general algorithms, such as AES (FIPS PUB 197), SHA (FIPS PUB 180-4), RSA, and ECC, which support independent arithmetic such as Big Integer Multiplication and Big Integer Modular Multiplication. The maximum operation length for RSA, ECC, Big Integer Multiply and Big Integer Modular Multiplication is 4096 bits.

The hardware accelerators greatly improve operation speed and reduce software complexity. They also support code encryption and dynamic decryption which ensures that codes in the Flash will not be stolen.

5. Electrical Characteristics

Note:

The specifications in this chapter are tested in general condition: $V_{BAT} = 3.3V$, $T_A = 27^{\circ}C$, unless otherwise specified.

5.1 Absolute Maximum Ratings

Table 7: Absolute Maximum Ratings

Parameter	Symbol	Min	Max	Unit
Input low voltage	V_{IL}	-0.3	$0.25 \times V_{IO}$	V
Input high voltage	V_{IH}	$0.75 \times V_{IO}$	3.3	V
Input leakage current	I_{IL}	-	50	nA
Output low voltage	V_{OL}	-	$0.1 \times V_{IO}$	V
Output high voltage	V_{OH}	$0.8 \times V_{IO}$	-	V
Input pin capacitance	C_{pad}	-	2	pF
VDDIO	V_{IO}	1.8	3.3	V
Maximum drive capability	I_{MAX}	-	12	mA
Storage temperature range	T_{STR}	-40	150	$^{\circ}C$

5.2 Recommended Operating Conditions

Table 8: Recommended Operating Conditions

Parameter	Symbol	Min	Typ	Max	Unit
Battery regulator supply voltage	V_{BAT}	2.8	3.3	3.6	V
I/O supply voltage	V_{IO}	1.8	3.3	3.6	V
Operating temperature range	T_{OPR}	-40	-	125	$^{\circ}C$
CMOS low level input voltage	V_{IL}	0	-	$0.3 \times V_{IO}$	V
CMOS high level input voltage	V_{IH}	$0.7 \times V_{IO}$	-	V_{IO}	V
CMOS threshold voltage	V_{TH}	-	$0.5 \times V_{IO}$	-	V

5.3 RF Power Consumption Specifications

The current consumption measurements are conducted with 3.0 V supply and 25°C ambient, at antenna port. All the transmitters' measurements are based on 90% duty cycle and continuous transmit mode.

Table 9: RF Power Consumption Specifications

Mode	Min	Typ	Max	Unit
Transmit 802.11b, DSSS 1 Mbps, POUT = +19.5 dBm	-	225	-	mA
Transmit 802.11b, CCK 11 Mbps, POUT = +18.5 dBm	-	205	-	mA
Transmit 802.11g, OFDM 54 Mbps, POUT = +16 dBm	-	160	-	mA
Transmit 802.11n, MCS7, POUT = +14 dBm	-	152	-	mA
Receive 802.11b, packet length = 1024 bytes, -80 dBm	-	85	-	mA
Receive 802.11g, packet length = 1024 bytes, -70 dBm	-	85	-	mA
Receive 802.11n, packet length = 1024 bytes, -65 dBm	-	80	-	mA
Receive 802.11n HT40, packet length = 1024 bytes, -65 dBm	-	80	-	mA

5.4 Wi-Fi Radio

Table 10: Wi-Fi Radio Characteristics

Description	Min	Typical	Max	Unit
Input frequency	2412	-	2484	MHz
Input impedance	-	50	-	Ω
Input reflection	-	-	-10	dB
Output power of PA for 72.2 Mbps	15.5	16.5	17.5	dBm
Output power of PA for 11b mode	19.5	20.5	21.5	dBm
DSSS, 1 Mbps	-	-98	-	dBm
CCK, 11 Mbps	-	-91	-	dBm
OFDM, 6 Mbps	-	-93	-	dBm
OFDM, 54 Mbps	-	-75	-	dBm
HT20, MCS0	-	-93	-	dBm
HT20, MCS7	-	-73	-	dBm
HT40, MCS0	-	-90	-	dBm
HT40, MCS7	-	-70	-	dBm
MCS32	-	-89	-	dBm
OFDM, 6 Mbps	-	37	-	dB
OFDM, 54 Mbps	-	21	-	dB
HT20, MCS0	-	37	-	dB
HT20, MCS7	-	20	-	dB

5.5 Bluetooth Radio

5.5.1 Receiver - Basic Data Rate

Table 11: Receiver Characteristics-Basic Data Rate

Parameter	Conditions	Min	Typ	Max	Unit
Sensitivity @0.1% BER	-	-	-98	-	dBm
Maximum received signal @0.1% BER	-	0	-	-	dBm
Co-channel C/I	-	-	+7	-	dB
Adjacent channel selectivity C/I	F = F0 + 1 MHz	-	-	-6	dB
	F = F0 - 1 MHz	-	-	-6	dB
	F = F0 + 2 MHz	-	-	-25	dB
	F = F0 - 2 MHz	-	-	-33	dB
	F = F0 + 3 MHz	-	-	-25	dB
	F = F0 - 3 MHz	-	-	-45	dB
Out-of-band blocking performance	30 MHz ~ 2000 MHz	-10	-	-	dBm
	2000 MHz ~ 2400 MHz	-27	-	-	dBm
	2500 MHz ~ 3000 MHz	-27	-	-	dBm
	3000 MHz ~ 12.5 GHz	-10	-	-	dBm
Intermodulation	-	-36	-	-	dBm

5.5.2 Transmitter - Basic Data Rate

Table 12: Transmitter Characteristics - Basic Data Rate

Parameter	Conditions	Min	Typ	Max	Unit
RF transmit power	-	-	+4	+4	dBm
RF power control range	-	-	25	-	dB
20 dB bandwidth	-	-	0.9	-	MHz
Adjacent channel transmit power	F = F0 + 1 MHz	-	-24	-	dBm
	F = F0 - 1 MHz	-	-16.1	-	dBm
	F = F0 + 2 MHz	-	-40.8	-	dBm
	F = F0 - 2 MHz	-	-35.6	-	dBm
	F = F0 + 3 MHz	-	-45.7	-	dBm
	F = F0 - 3 MHz	-	-40.2	-	dBm
	F = F0 + > 3 MHz	-	-45.6	-	dBm
	F = F0 - > 3 MHz	-	-44.6	-	dBm
$\Delta f1_{avg}$	-	-	-	155	kHz
$\Delta f2_{max}$	-	133.7	-	-	kHz
$\Delta f2_{avg}/\Delta f1_{avg}$	-	-	0.92	-	-
ICFT	-	-	-7	-	kHz
Drift rate	-	-	0.7	-	kHz/50 μ s
Drift (1 slot packet)	-	-	6	-	kHz
Drift (5 slot packet)	-	-	6	-	kHz

5.5.3 Receiver - Enhanced Data Rate

Table 13: Receiver Characteristics - Enhanced Data Rate

Parameter	Conditions	Min	Typ	Max	Unit
$\pi/4$ DQPSK					
Sensitivity @0.01% BER	-	-	-98	-	dBm
Maximum received signal @0.1% BER	-	-	0	-	dBm
Co-channel C/I	-	-	11	-	dB
Adjacent channel selectivity C/I	F = F0 + 1 MHz	-	-7	-	dB
	F = F0 - 1 MHz	-	-7	-	dB
	F = F0 + 2 MHz	-	-25	-	dB
	F = F0 - 2 MHz	-	-35	-	dB
	F = F0 + 3 MHz	-	-25	-	dB
	F = F0 - 3 MHz	-	-45	-	dB
8DPSK					
Sensitivity @0.01% BER	-	-	-84	-	dBm
Maximum received signal @0.1% BER	-	0	-	-	dBm
C/I c-channel	-	-	18	-	dB
Adjacent channel selectivity C/I	F = F0 + 1 MHz	-	2	-	dB
	F = F0 - 1 MHz	-	2	-	dB
	F = F0 + 2 MHz	-	-25	-	dB
	F = F0 - 2 MHz	-	-25	-	dB
	F = F0 + 3 MHz	-	-25	-	dB
	F = F0 - 3 MHz	-	-38	-	dB

5.5.4 Transmitter - Enhanced Data Rate

Table 14: Transmitter Characteristics - Enhanced Data Rate

Parameter	Conditions	Min	Typ	Max	Unit
Maximum RF transmit power	-	-	+2	-	dBm
Relative transmit control	-	-	-1.5	-	dB
$\pi/4$ DQPSK max w0	-	-	-0.72	-	kHz
$\pi/4$ DQPSK max wi	-	-	-6	-	kHz
$\pi/4$ DQPSK max wi + w0	-	-	-7.42	-	kHz
8DPSK max w0	-	-	0.7	-	kHz
8DPSK max wi	-	-	-9.6	-	kHz
8DPSK max wi + w0	-	-	-10	-	kHz
$\pi/4$ DQPSK modulation accuracy	RMS DEVM	-	4.28	-	%
	99% DEVM	-	-	30	%
	Peak DEVM	-	13.3	-	%
8 DPSK modulation accuracy	RMS DEVM	-	5.8	-	%
	99% DEVM	-	-	20	%
	Peak DEVM	-	14	-	%

Parameter	Conditions	Min	Typ	Max	Unit
In-band spurious emissions	F = F0 + 1 MHz	-	-34	-	dBm
	F = F0 - 1 MHz	-	-40.2	-	dBm
	F = F0 + 2 MHz	-	-34	-	dBm
	F = F0 - 2 MHz	-	-36	-	dBm
	F = F0 + 3 MHz	-	-38	-	dBm
	F = F0 - 3 MHz	-	-40.3	-	dBm
	F = F0 +/- > 3 MHz	-	-	-41.5	dBm
EDR differential phase coding	-	-	100	-	%

5.6 Bluetooth LE Radio

5.6.1 Receiver

Table 15: Receiver Characteristics - BLE

Parameter	Conditions	Min	Typ	Max	Unit
Sensitivity @0.1% BER	-	-	-98	-	dBm
Maximum received signal @0.1% BER	-	0	-	-	dBm
Co-channel C/I	-	-	+10	-	dB
Adjacent channel selectivity C/I	F = F0 + 1 MHz	-	-5	-	dB
	F = F0 - 1 MHz	-	-5	-	dB
	F = F0 + 2 MHz	-	-25	-	dB
	F = F0 - 2 MHz	-	-35	-	dB
	F = F0 + 3 MHz	-	-25	-	dB
	F = F0 - 3 MHz	-	-45	-	dB
Out-of-band blocking performance	30 MHz ~ 2000 MHz	-10	-	-	dBm
	2000 MHz ~ 2400 MHz	-27	-	-	dBm
	2500 MHz ~ 3000 MHz	-27	-	-	dBm
	3000 MHz ~ 12.5 GHz	-10	-	-	dBm
Intermodulation	-	-36	-	-	dBm

5.6.2 Transmitter

Table 16: Transmitter Characteristics - BLE

Parameter	Conditions	Min	Typ	Max	Unit
RF transmit power	-	-	+7.5	+10	dBm
RF power control range	-	-	25	-	dB
Adjacent channel transmit power	F = F0 + 1 MHz	-	-14.6	-	dBm
	F = F0 - 1 MHz	-	-12.7	-	dBm
	F = F0 + 2 MHz	-	-44.3	-	dBm
	F = F0 - 2 MHz	-	-38.7	-	dBm
	F = F0 + 3 MHz	-	-49.2	-	dBm
	F = F0 - 3 MHz	-	-44.7	-	dBm
	F = F0 + > 3 MHz	-	-50	-	dBm

Parameter	Conditions	Min	Typ	Max	Unit
	F = F0 - > 3 MHz	-	-50	-	dBm
$\Delta f1_{avg}$	-	-	-	265	kHz
$\Delta f2_{max}$	-	247	-	-	kHz
$\Delta f2_{avg}/\Delta f1_{avg}$	-	-	-0.92	-	-
ICFT	-	-	-10	-	kHz
Drift rate	-	-	0.7	-	kHz/50 μ s
Drift	-	-	2	-	kHz

6. Package Information

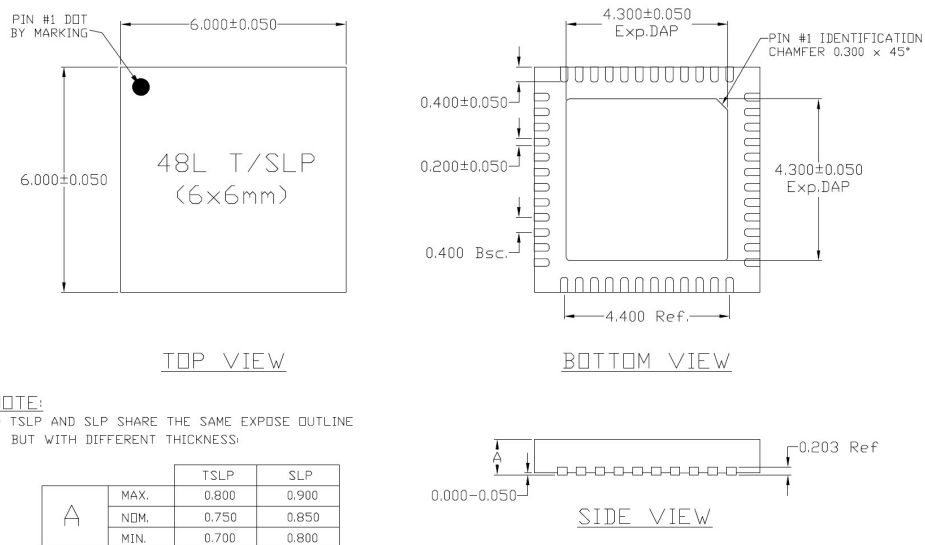

Figure 4: QFN48 (6x6 mm) Package

7. Supported Resources

7.1 Related Documentation

The following link provides related documents of ESP32.

- [ESP32 Documentation](#)
All the available documentation and other resources of ESP32

7.2 Community Resources

The following links connect to ESP32 community resources.

- [ESP32 Online Community](#)
An Engineer-to-Engineer (E2E) Community for ESP32 where you can ask questions, share knowledge, explore ideas and help solve problems with fellow engineers.
- [ESP32 Github](#)
ESP32 development projects are freely distributed under Espressif's MIT license on Github. It is established to help developers get started with ESP32 and foster innovation and the growth of general knowledge about the hardware and software surrounding these devices.

Appendix A - Touch Sensor

A touch sensor system is built on a substrate which carries electrodes and relevant connections with a flat protective surface. When a user touches the surface, the capacitance variation is triggered, and a binary signal is generated to indicate whether the touch is valid.

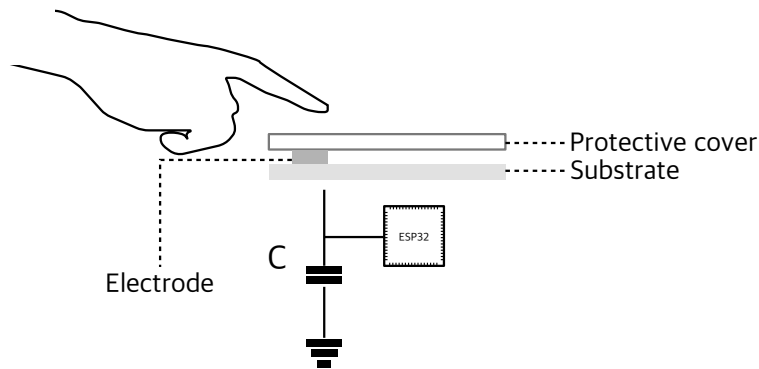

Figure 5: A Typical Touch Sensor Application

In order to prevent capacitive coupling and other electrical interference to the sensitivity of the touch sensor system, the following factors should be taken into account.

A.1. Electrode Pattern

The proper size and shape of an electrode helps improve system sensitivity. Round, oval, or shapes similar to a human fingertip is commonly applied. Large size or irregular shape might lead to incorrect responses from nearby electrodes.

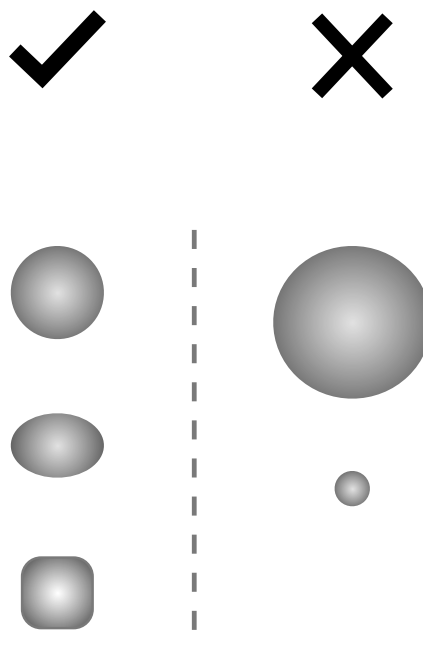

Figure 6: Electrode Pattern Requirements

Note:

The examples illustrated in Figure 6 are not of actual scale. It is suggested that users take a human fingertip as reference.

A.2. PCB Layout

The recommendations for correctly routing sensing tracks of electrodes are as follows:

- Close proximity between electrodes may lead to crosstalk between electrodes and false touch detections. The distance between electrodes should be at least twice the thickness of the panel used.
- The width of a sensor track creates parasitic capacitance, which could vary with manufacturing processes. The thinner the track is, the less capacitive coupling it generates. The track width should be kept as thin as possible and the length should not exceed 10cm to accommodate.
- We should avoid coupling between lines of high frequency signals. The sensing tracks should be routed parallel to each other on the same layer and the distance between the tracks should be at least twice the width of the track.
- When designing a touch sensor device, there should be no components adjacent to or underneath the electrodes.
- Do not ground the touch sensor device. It is preferable that no ground layer be placed under the device, unless there is a need to isolate it. Parasitic capacitance generated between the touch sensor device and the ground degrades sensitivity.

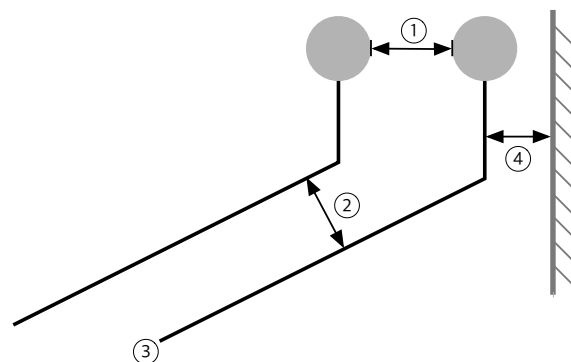

- ① Distance between electrodes - Twice the thickness of the panel
- ② Distance between tracks - Twice the track width
- ③ Width of the track (electrode wiring) - As thin as possible
- ④ Distance between track and ground plane - 2mm at a minimum

Figure 7: Sensor Track Routing Requirements

Appendix B - Code Examples

B.1. Input

```
>python esptool.py -p dev/tty8 -b 115200 write_Flash -c ESP32 -ff 40m -fm qio -fs 2MB
0x0 ~/Workspace/ESP32_BIN/boot.bin
0x04000 ~/Workspace/ESP32_BIN/drom0.bin
0x40000 ~/Workspace/ESP32_BIN/bin/irom0_Flash.bin
0xFC000 ~/Workspace/ESP32_BIN/blank.bin
0x1FC000 ~/Workspace/ESP32_BIN/esp_init_data_default.bin
```

B.2. Output

```
Connecting...
Erasing Flash...
Wrote 3072 bytes at 0x00000000 in 0.3 seconds (73.8 kbit/s)...
Erasing Flash...
Wrote 395264 bytes at 0x04000000 in 43.2 seconds (73.2 kbit/s)...
Erasing Flash...
Wrote 1024 bytes at 0x40000000 in 0.1 seconds (74.5 kbit/s)...
Erasing Flash...
Wrote 4096 bytes at 0xfc000000 in 0.4 seconds (73.5 kbit/s)...
Erasing Flash...
Wrote 4096 bytes at 0x1fc00000 in 0.5 seconds (73.8 kbit/s)...
Leaving...
```